

Article number: 2301072656  
 Description: E+G Handwheel  
 VDS.80+IR-A8

## Measures

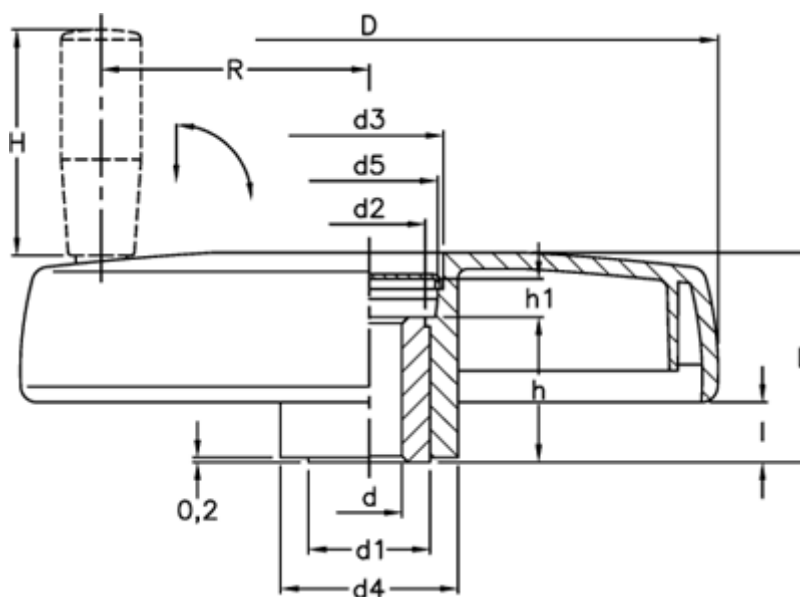

C (N m) = 34	H = 45
D = 83	h = 17
d1 = 18	h1 = 3.5
d2 = 16.0	l = 18.5
d3 = 16.5	L = 38
d4 = 25	L (J) = 6
d5 = 13.5	R = 28
d H7 = 8	